

# Verkehrsdaten Mainz - Zählstelle

## Video - Frauenlobstraße / Forsterstraße Di 14.03.2023



Landeshauptstadt  
Mainz

1008536

41129



41110

1008539

Knoten-Nr :

**1008537**

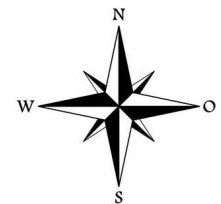

Stadt Mainz  
61.1-Stadtplanungsamt  
Abtlg. Verkehrswesen

10.05.2023 scar

# Tagessummenreport

Zählstelle: Forsterstraße/Frauenlobstraße

Gesamt

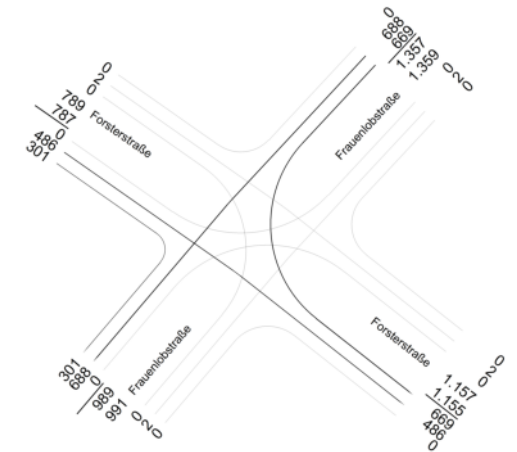
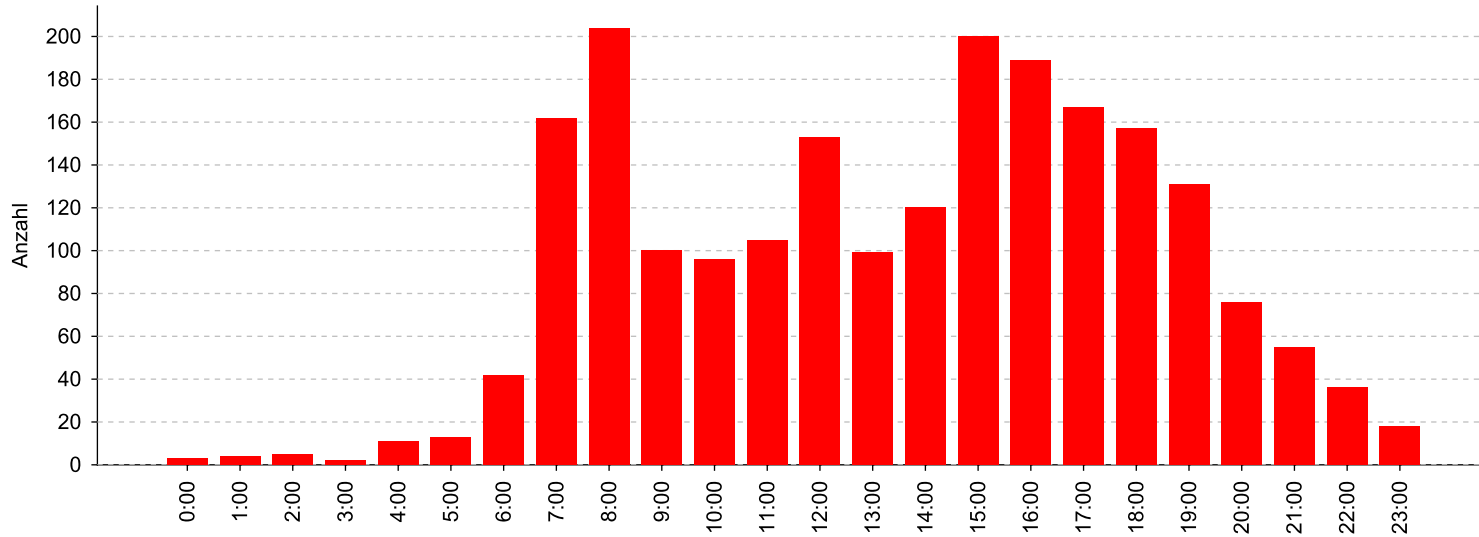

Di., 14.03.2023	0:00	1:00	2:00	3:00	4:00	5:00	6:00	7:00	8:00	9:00	10:00	11:00	12:00	13:00	14:00	15:00	16:00	17:00	18:00	19:00	20:00	21:00	22:00	23:00	Ges.
<b>KFZ (Einzel+Dauerzählung)</b>	3	4	5	2	11	13	42	162	204	100	96	105	153	99	120	200	189	167	157	131	76	55	36	18	2.148

# Tagessummenreport

Zählstelle: Forsterstraße/Frauenlobstraße

Forsterstraße aus Südosten

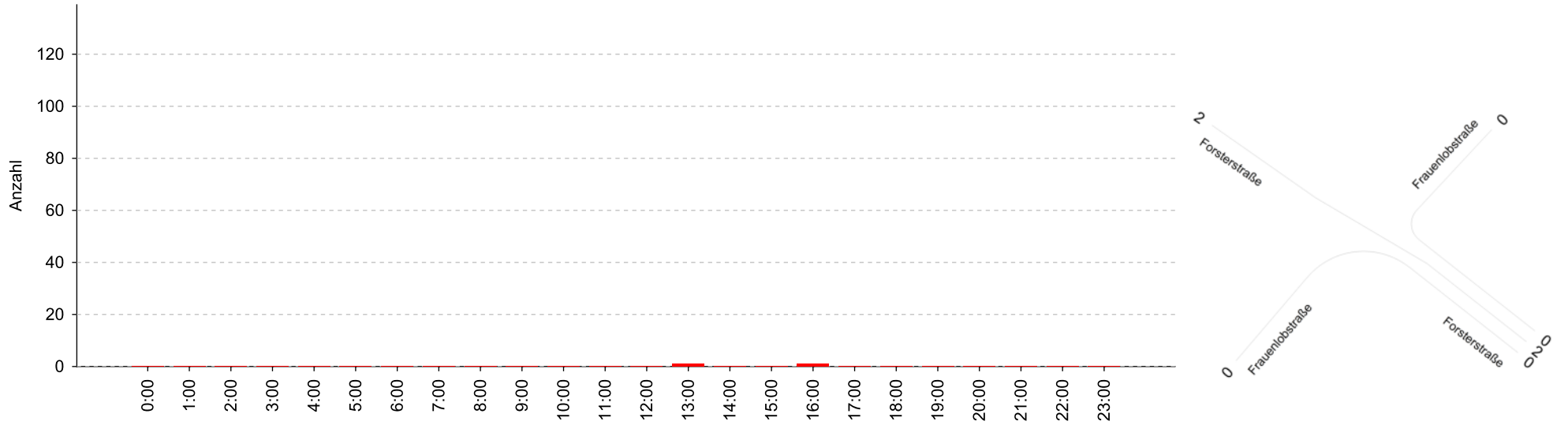

Di., 14.03.2023	0:00	1:00	2:00	3:00	4:00	5:00	6:00	7:00	8:00	9:00	10:00	11:00	12:00	13:00	14:00	15:00	16:00	17:00	18:00	19:00	20:00	21:00	22:00	23:00	Ges.	
<b>KFZ</b> (Einzel+Dauerzählung)	0	0	0	0	0	0	0	0	0	0	0	0	0	1	0	0	1	0	0	0	0	0	0	0	0	2

# Tagessummenreport

## Zählstelle: Forsterstraße/Frauenlobstraße

### Frauenlobstraße aus Südwesten

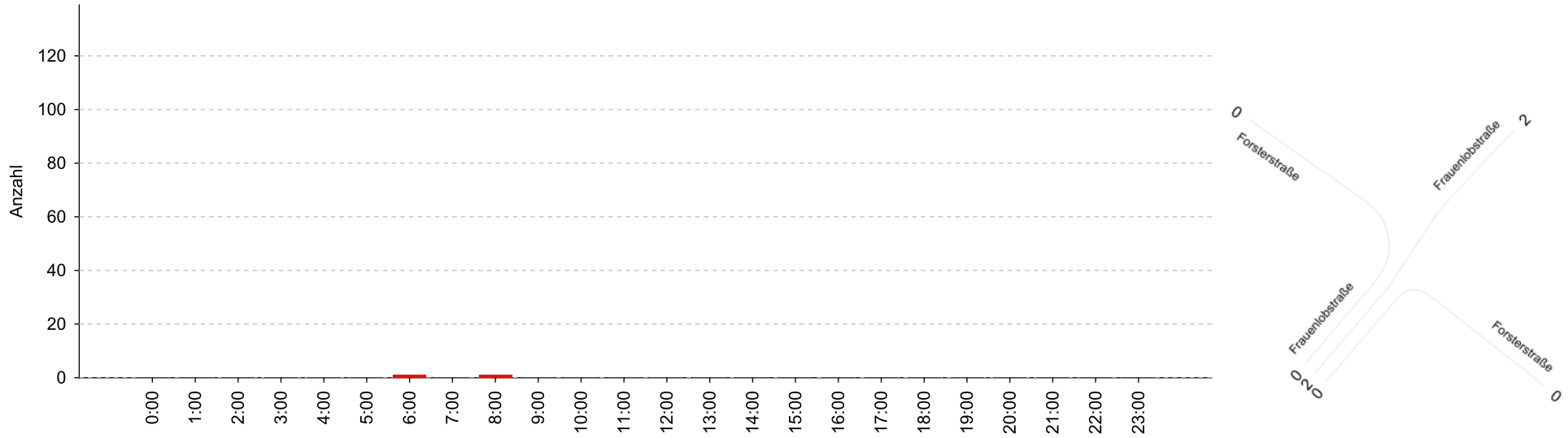

Di., 14.03.2023	0:00	1:00	2:00	3:00	4:00	5:00	6:00	7:00	8:00	9:00	10:00	11:00	12:00	13:00	14:00	15:00	16:00	17:00	18:00	19:00	20:00	21:00	22:00	23:00	Ges.	
<b>KFZ</b> (Einzel+Dauerzählung)	0	0	0	0	0	0	1	0	1	0	0	0	0	0	0	0	0	0	0	0	0	0	0	0	0	2

# Tagessummenreport

Zählstelle: Forsterstraße/Frauenlobstraße

Forsterstraße aus Nordwesten

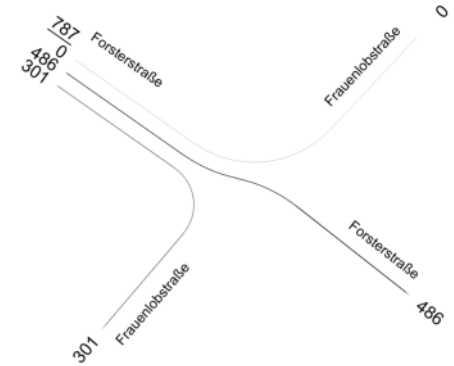
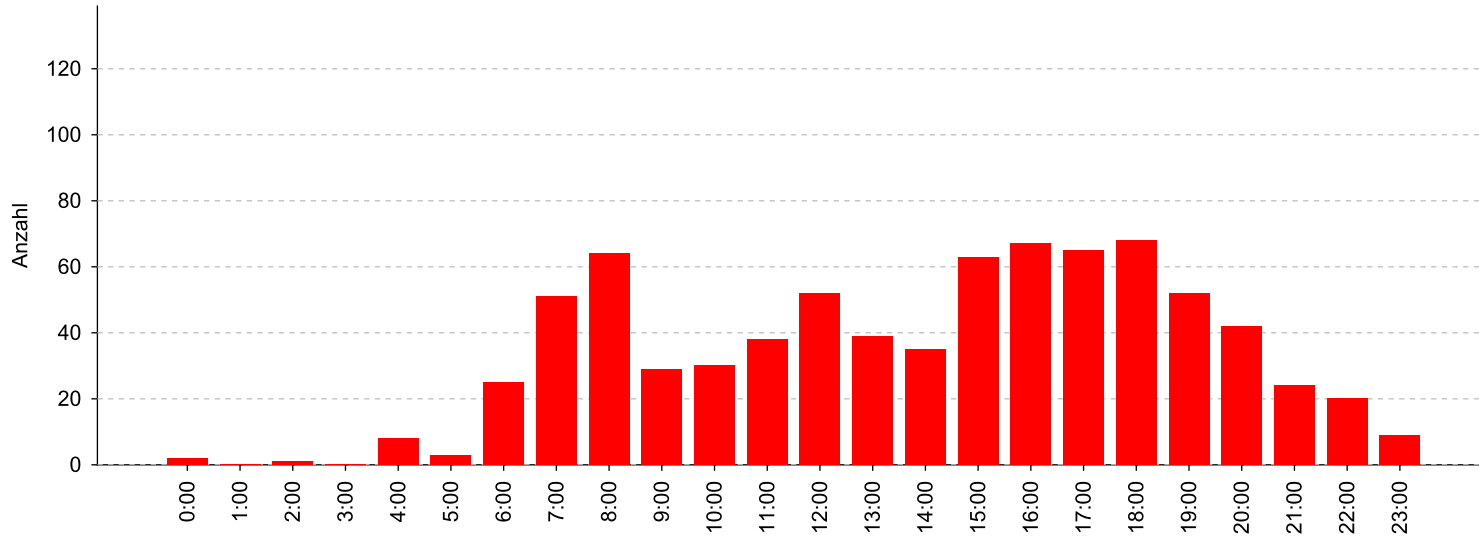

Di., 14.03.2023	0:00	1:00	2:00	3:00	4:00	5:00	6:00	7:00	8:00	9:00	10:00	11:00	12:00	13:00	14:00	15:00	16:00	17:00	18:00	19:00	20:00	21:00	22:00	23:00	Ges.
<b>KFZ (Einzel+Dauerzählung)</b>	2	0	1	0	8	3	25	51	64	29	30	38	52	39	35	63	67	65	68	52	42	24	20	9	787

# Tagessummenreport

Zählstelle: Forsterstraße/Frauenlobstraße

Frauenlobstraße aus Nordosten

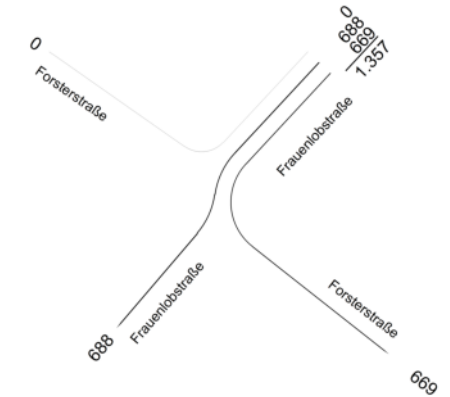
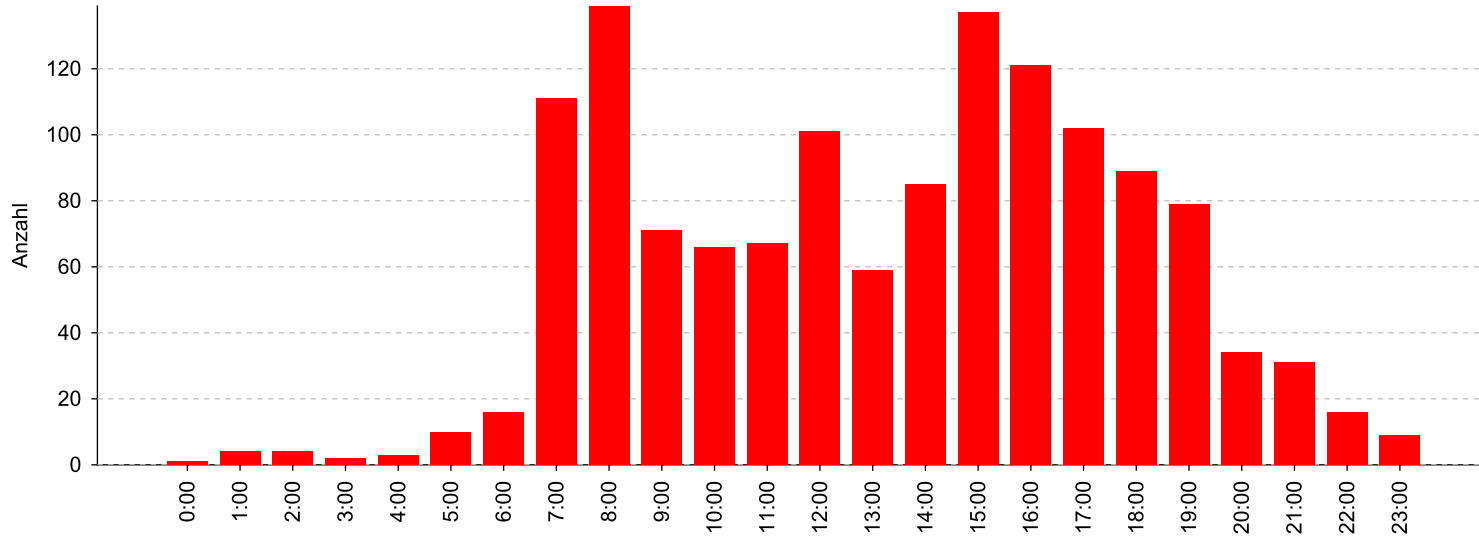

Di., 14.03.2023	0:00	1:00	2:00	3:00	4:00	5:00	6:00	7:00	8:00	9:00	10:00	11:00	12:00	13:00	14:00	15:00	16:00	17:00	18:00	19:00	20:00	21:00	22:00	23:00	Ges.
<b>KFZ (Einzel+Dauerzählung)</b>	1	4	4	2	3	10	16	111	139	71	66	67	101	59	85	137	121	102	89	79	34	31	16	9	1.357

# KNOTENSTROM - BELASTUNGSPLAN



Landeshauptstadt  
Mainz

## Knoten Frauenlobstraße / Forsterstraße Di. 14.03.2023

Vormittagsspitze  
08:00 - 09:00 Uhr  
in Kfz/h

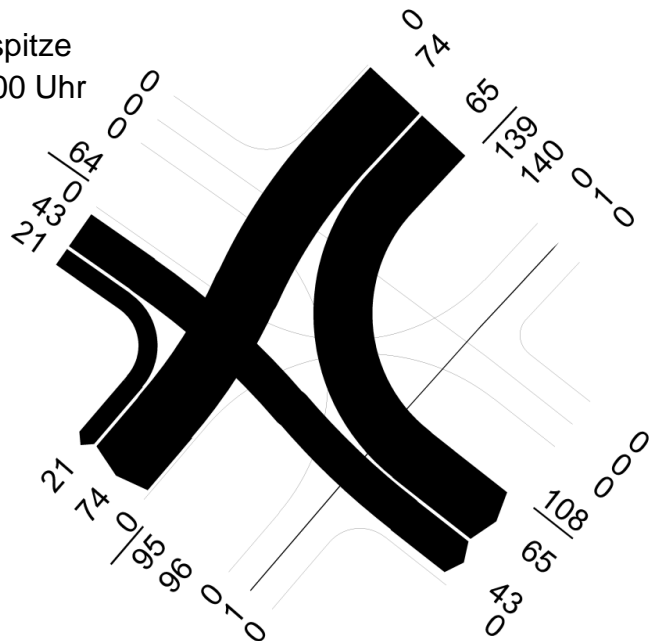

Nachmittagsspitze  
15.30- 16.30 Uhr  
in Kfz/h

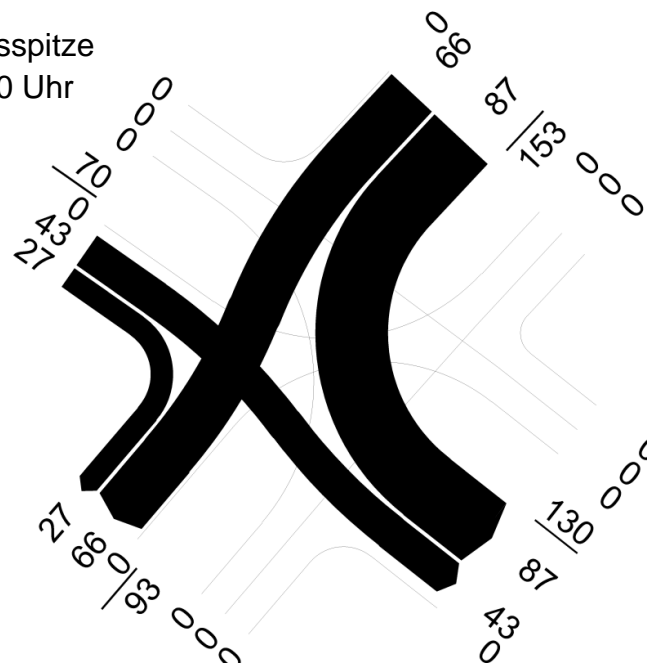

Tageswert  
0.00 - 24.00 Uhr  
in Kfz/24h

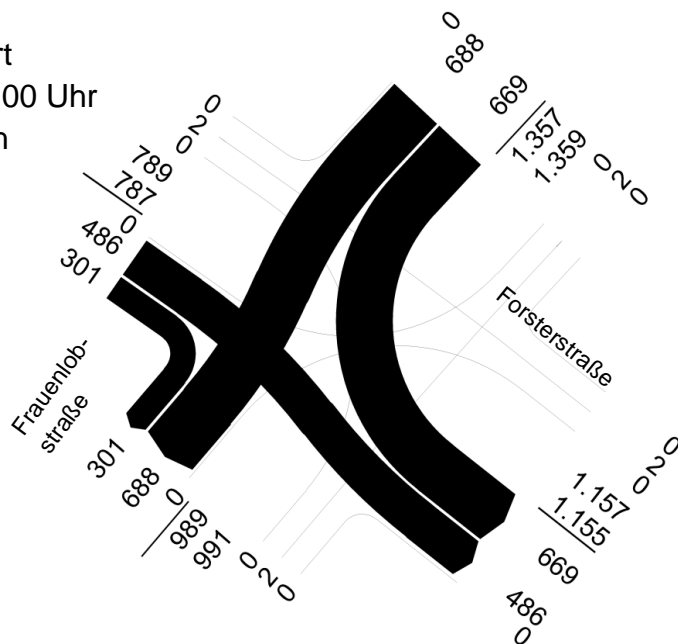

Schwerverkehr  
0.00 - 24.00 Uhr  
in SV/24h

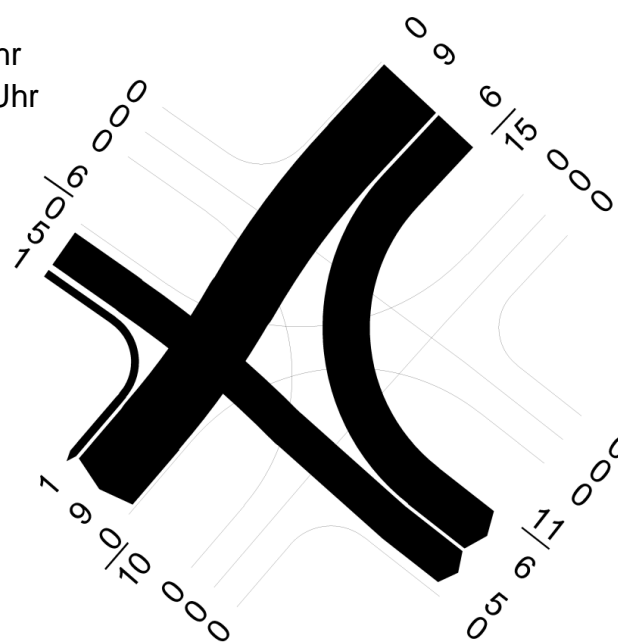

Knoten-Nr :

**1008537**

Stadt Mainz  
61.1-Stadtplanungsamt  
Abtlg. Verkehrswesen

11.05.2023 scar



# RADKNOTENSTROM - BELASTUNGSPLAN



Landeshauptstadt  
Mainz

## RAD - Knoten Frauenlobstraße / Forsterstraße Di. 14.03.2023

Vormittagsspitze  
08:15 - 09:15 Uhr  
in Rad/h

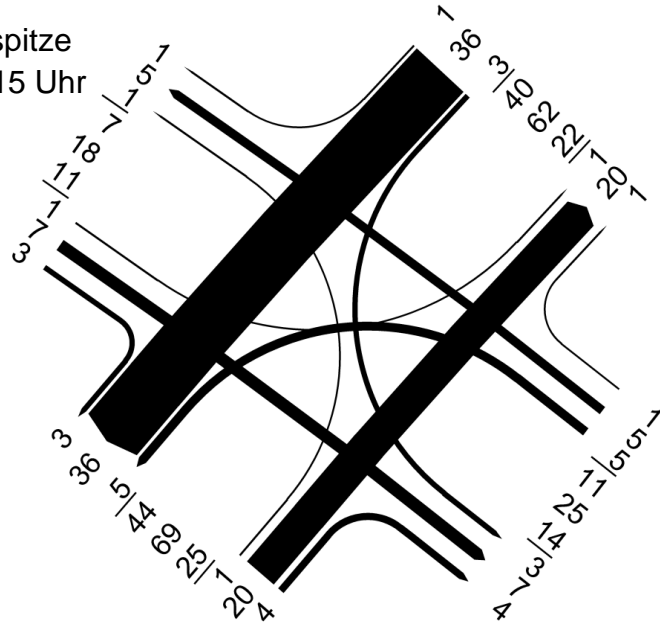

Nachmittagsspitze  
17.00- 18.00 Uhr  
in Rad/h

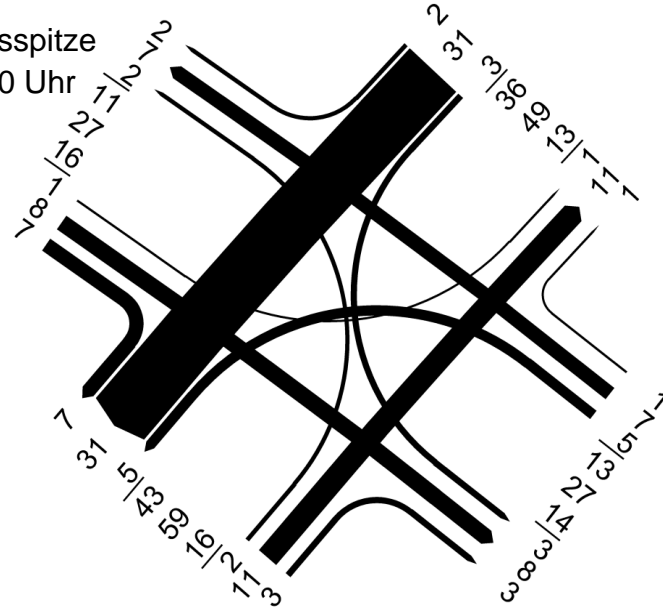

Tageswert  
0.00 - 24.00 Uhr  
in Rad/24h

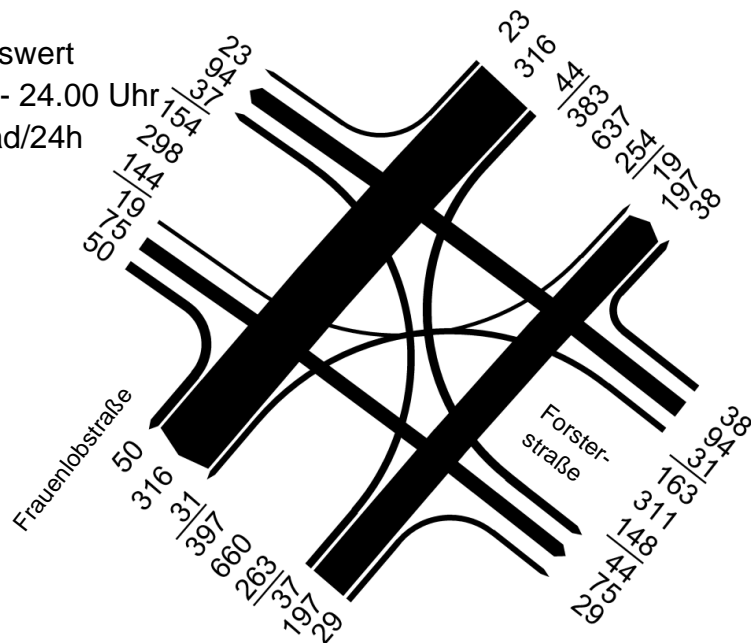

Knoten-Nr :

**1008537**

Stadt Mainz  
61.1-Stadtplanungsamt  
Abtlg. Verkehrswesen

11.05.2023 scar



# KNOTENSTROM - BELASTUNGSPLAN



Landeshauptstadt  
Mainz

## SCHWERVERKEHR - Knoten Hauptstraße / Kreuzstraße Di. 14.03.2022

Tageswert  
6.00 - 22.00 Uhr  
in Kfz/16h

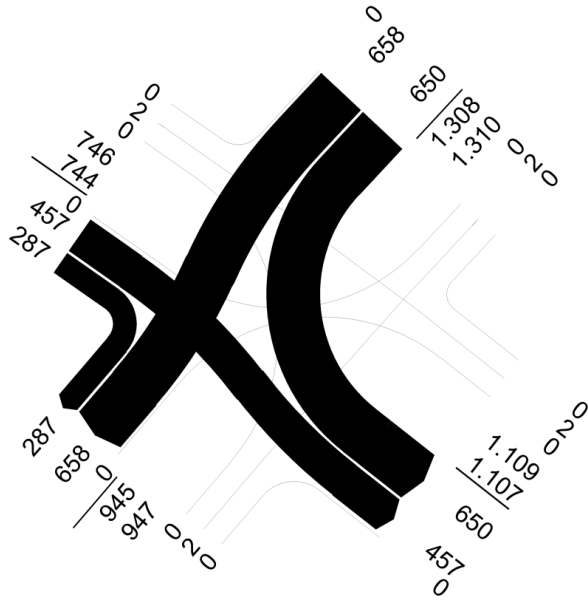

Tageswert  
6.00 - 22.00 Uhr  
in SV/16h

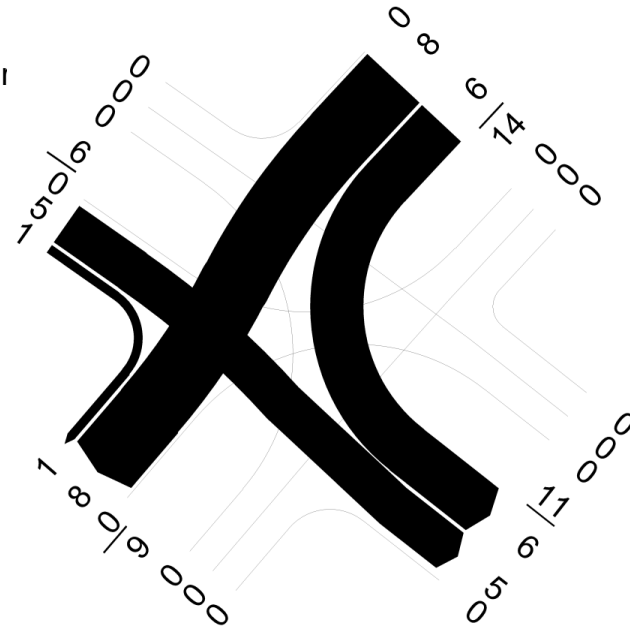

Nachtwert  
22.00 - 6.00 Uhr  
in Kfz/8h

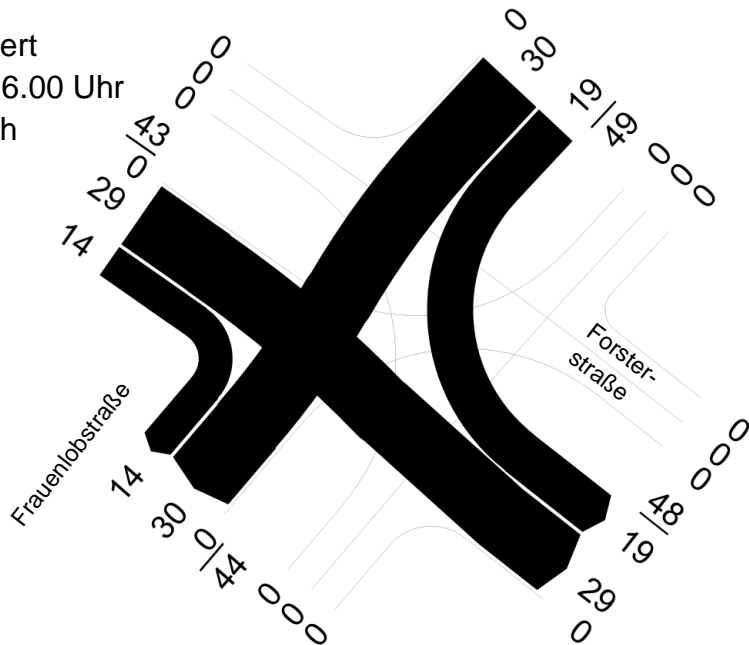

Nachtwert -  
Schwerverkehr  
22.00 - 6.00 Uhr  
in SV/8h

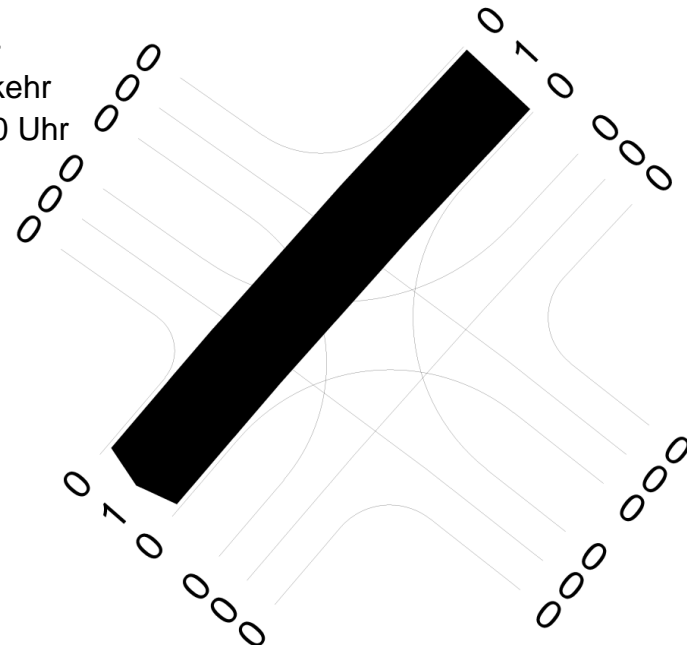

Knoten-Nr :

**1008537**

Stadt Mainz  
61.1-Stadtplanungsamt  
Abtlg. Verkehrswesen

11.05.2023 scar