

Verkehrsdaten Mainz - Zählstelle

Video - Kurmainzstraße / Poststraße 06.09.2022



Landeshauptstadt
Mainz



Knoten-Nr :

41403

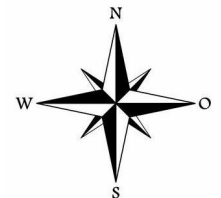

Stadt Mainz
61.1-Stadtplanungsamt
Abtlg. Verkehrswesen

20.10.2022 dm

Tagessummenreport

Zählstelle: Kurmainzstraße/Am Elmerberg

Kurmainzstraße aus Osten

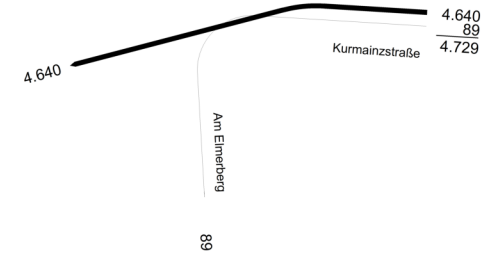
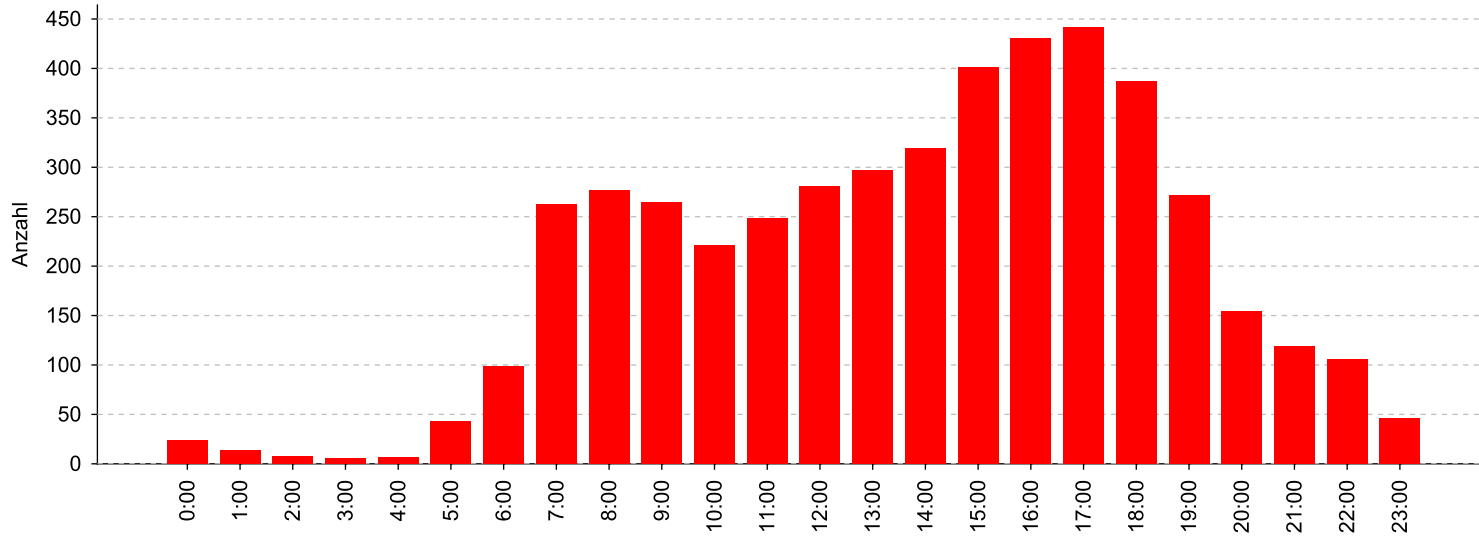

Di., 06.09.2022	0:00	1:00	2:00	3:00	4:00	5:00	6:00	7:00	8:00	9:00	10:00	11:00	12:00	13:00	14:00	15:00	16:00	17:00	18:00	19:00	20:00	21:00	22:00	23:00	Ges.
KFZ (Einzel+Dauerzählung)	24	14	8	6	7	43	99	263	277	265	221	248	281	297	319	401	430	442	387	272	154	119	106	46	4.729

Tagessummenreport

Zählstelle: Kurmainzstraße/Am Elmerberg

Am Elmerberg aus Süden

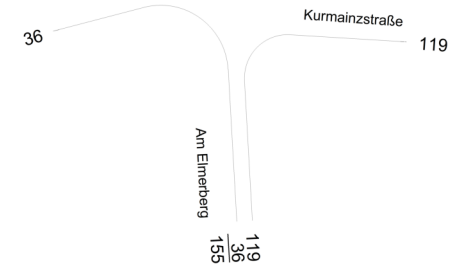
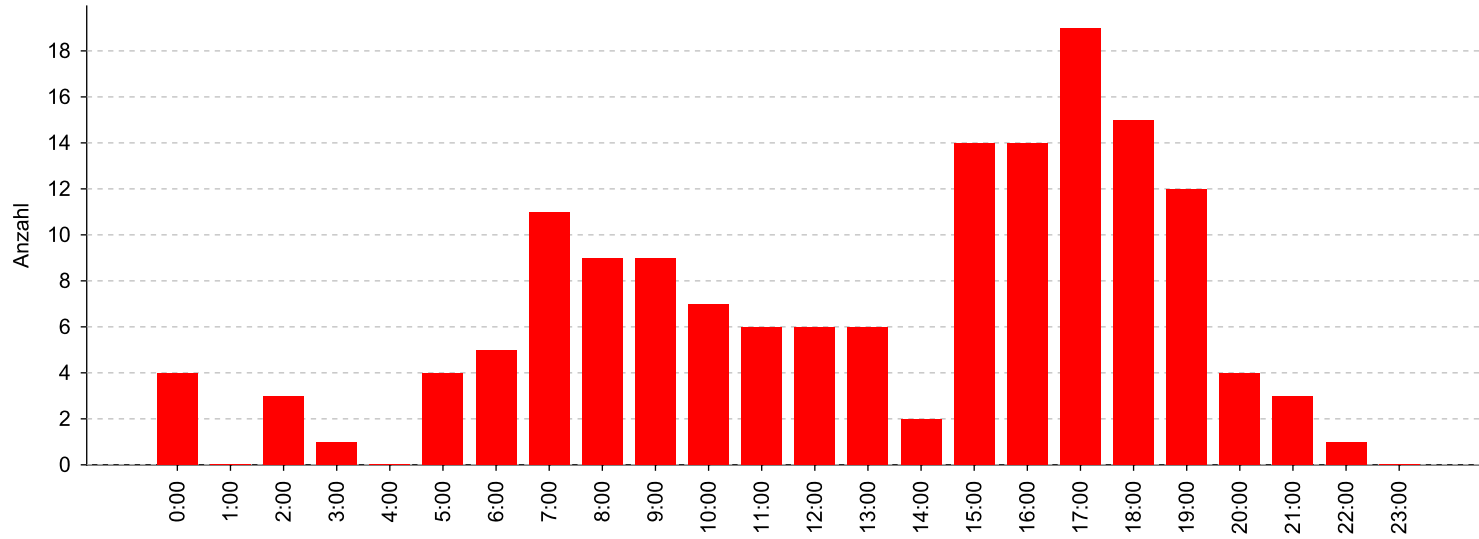

Di., 06.09.2022	0:00	1:00	2:00	3:00	4:00	5:00	6:00	7:00	8:00	9:00	10:00	11:00	12:00	13:00	14:00	15:00	16:00	17:00	18:00	19:00	20:00	21:00	22:00	23:00	Ges.
KFZ (Einzel+Dauerzählung)	4	0	3	1	0	4	5	11	9	9	7	6	6	6	2	14	14	19	15	12	4	3	1	0	155

Tagessummenreport

Zählstelle: Kurmainzstraße/Am Elmerberg

aus Westen

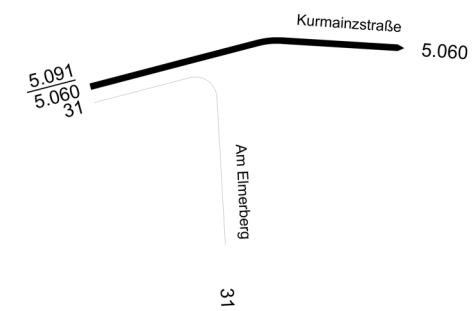
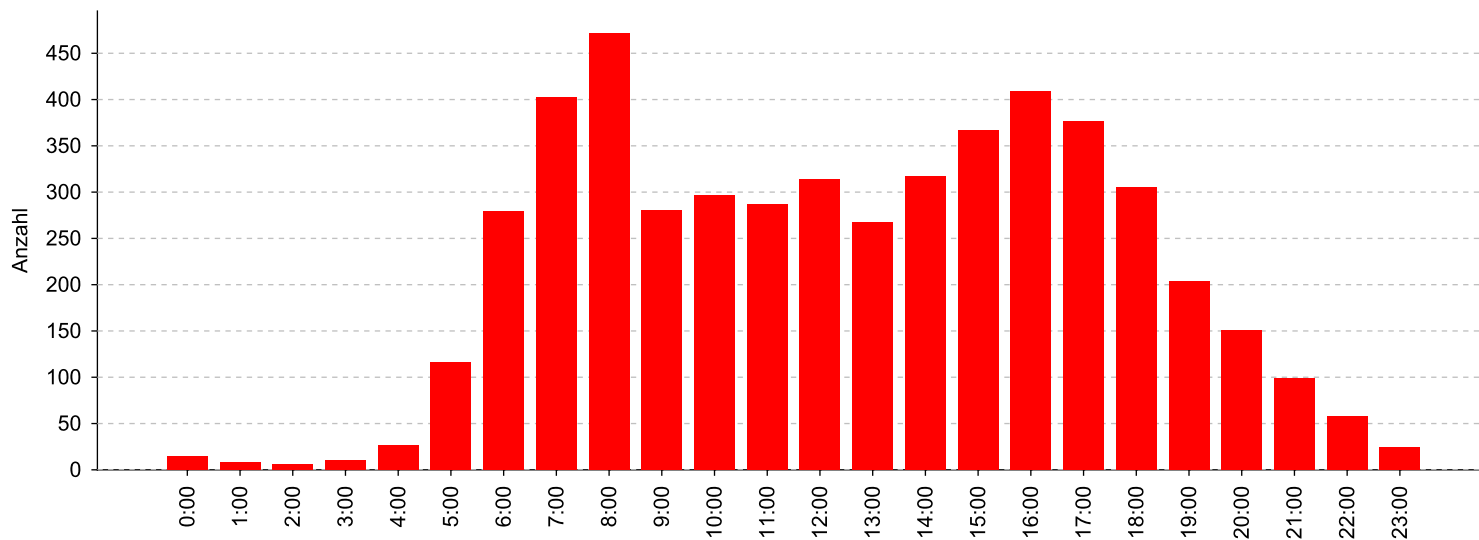

Di., 06.09.2022	0:00	1:00	2:00	3:00	4:00	5:00	6:00	7:00	8:00	9:00	10:00	11:00	12:00	13:00	14:00	15:00	16:00	17:00	18:00	19:00	20:00	21:00	22:00	23:00	Ges.
KFZ (Einzel+Dauerzählung)	15	8	6	10	27	116	279	402	472	280	297	287	314	267	317	367	409	377	305	204	151	99	58	24	5.091

Tagessummenreport

Zählstelle: Kurmainzstraße/Am Elmerberg

Poststraße aus Norden

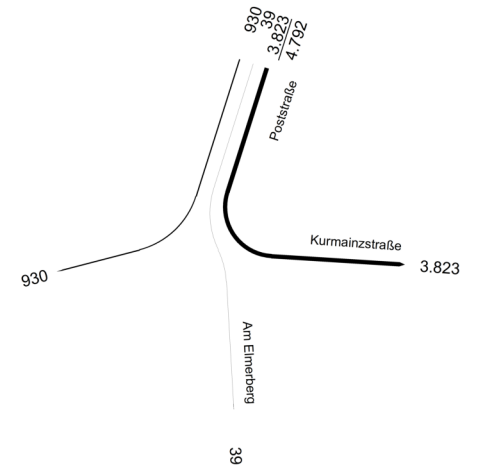
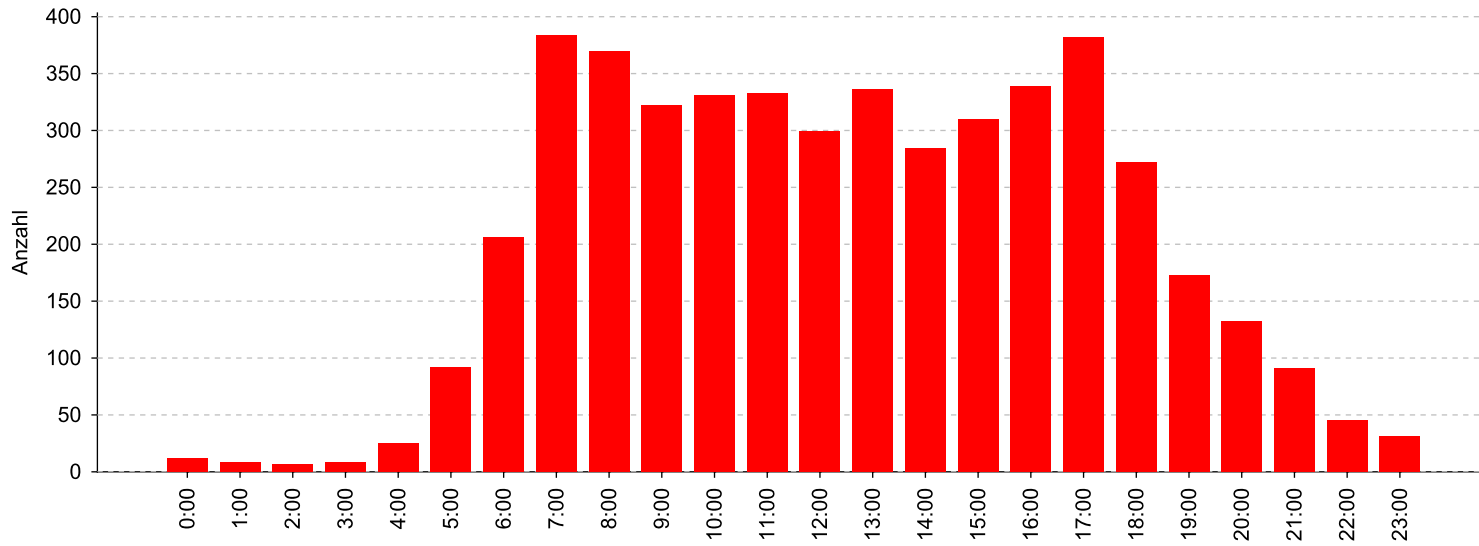

Di., 06.09.2022	0:00	1:00	2:00	3:00	4:00	5:00	6:00	7:00	8:00	9:00	10:00	11:00	12:00	13:00	14:00	15:00	16:00	17:00	18:00	19:00	20:00	21:00	22:00	23:00	Ges.
KFZ (Einzel+Dauerzählung)	12	8	7	8	25	92	206	384	370	322	331	333	299	336	284	310	339	382	272	173	132	91	45	31	4.792

KNOTENSTROM - BELASTUNGSPLAN



Landeshauptstadt
Mainz

Knoten Kurmainzstraße / Poststraße Di. 06.09.2022

Vormittagsspitze
07:30 - 08:30 Uhr
in Kfz/h

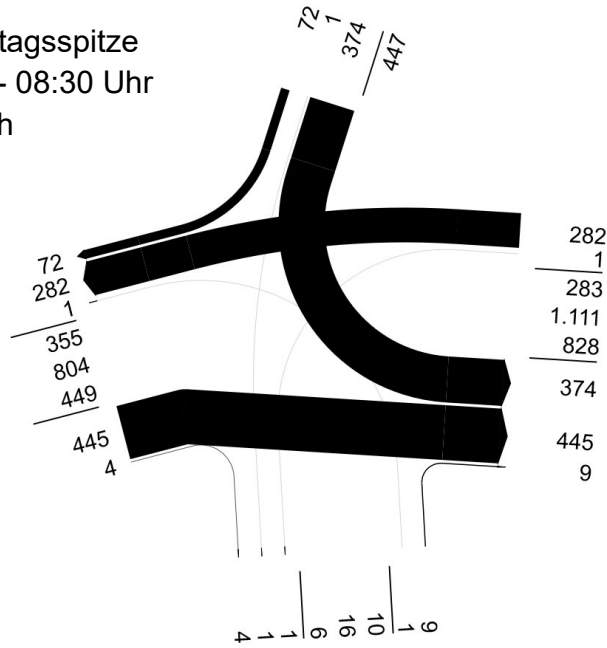

Nachmittagsspitze
16:30 - 17:30 Uhr
in Kfz/h

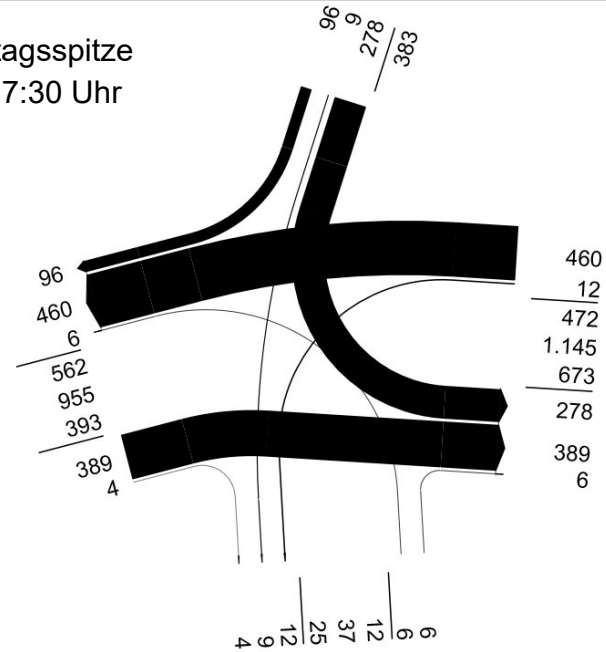

Tageswert
0:00 - 24:00 Uhr
in Kfz/24h

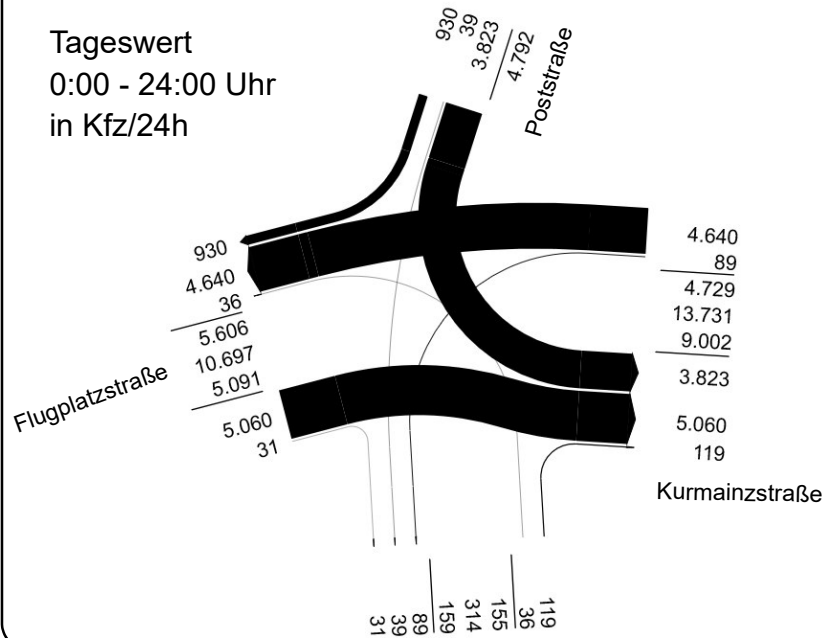

Schwerverkehr
0:00 - 24:00 Uhr
in SV/24h

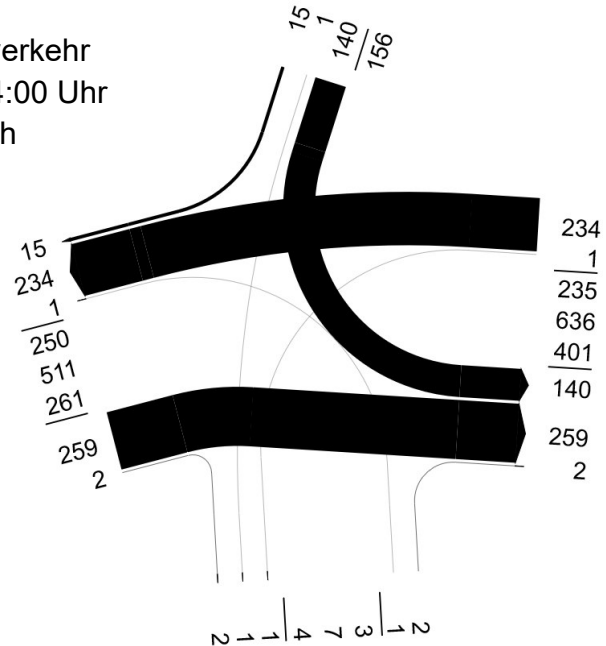

Knoten-Nr :

41403

Stadt Mainz
61.1-Stadtplanungsamt
Abtlg. Verkehrswesen

20.10.2022 dm

KNOTENSTROM - BELASTUNGSPLAN

RAD - Kurmainzstraße / Poststraße Di. 06.09.2022



Landeshauptstadt
Mainz

Vormittagsspitze
07:30- 08:30 Uhr
in Rad/h

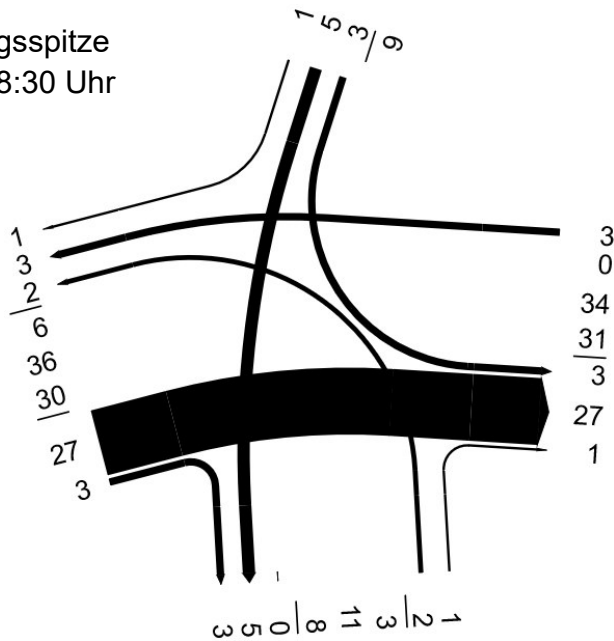

Nachmittagsspitze
16:15 - 17:15 Uhr
in Rad/h

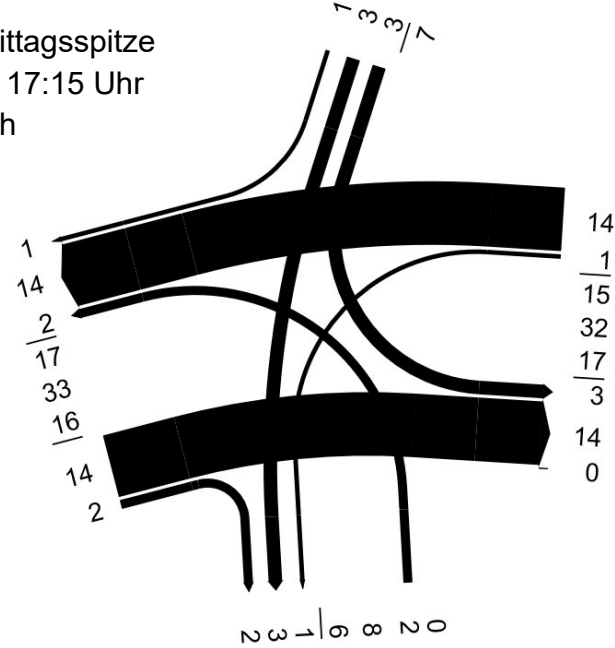

Tageswert
0:00 - 24:00 Uhr
in Rad/24h

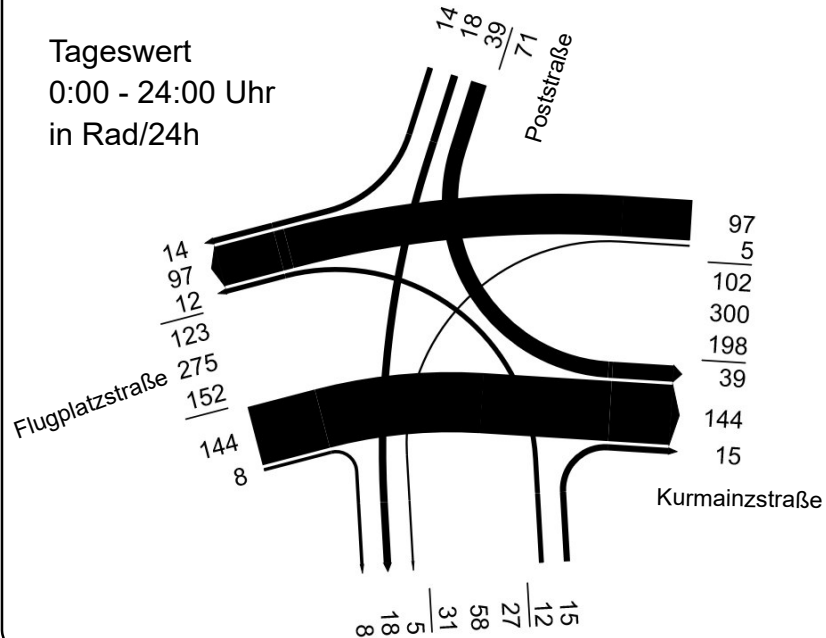

Knoten-Nr :

41403

Stadt Mainz
61.1-Stadtplanungsamt
Abtlg. Verkehrswesen

20.10.2022 dm

KNOTENSTROM - BELASTUNGSPLAN



Landeshauptstadt
Mainz

Schwerverkehr- Kurmainzstraße / Poststraße Di. 06.09.2022

Tageswert
6:00 - 22:00 Uhr
in Kfz/16h

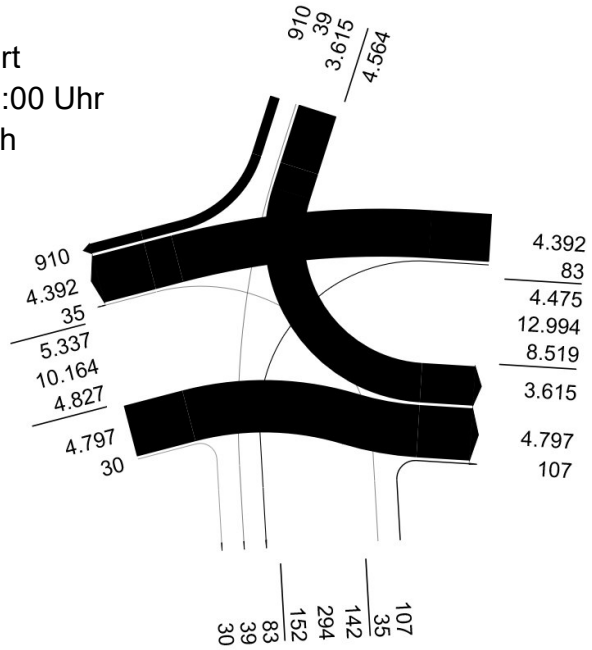

Tageswert
6:00 - 22:00 Uhr
in SV/16h

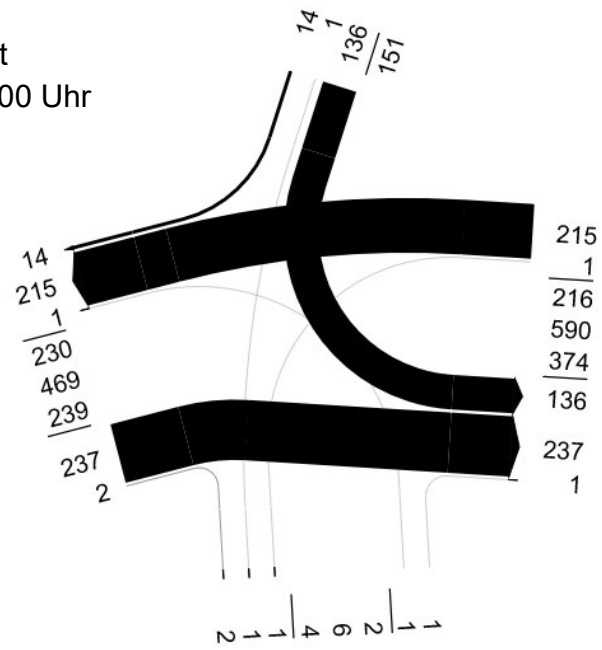

Nachtwert
22:00 - 6:00 Uhr
in Kfz/8h

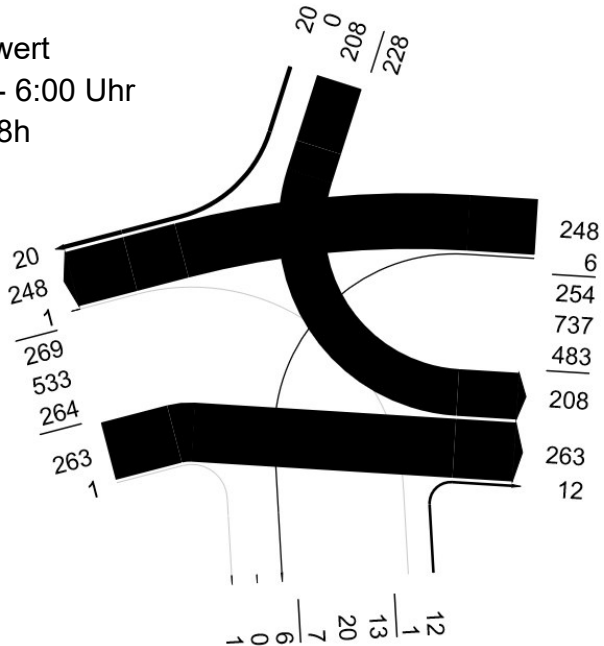

Nachtwert -
Schwerverkehr
22:00 - 6:00 Uhr
in SV/8h

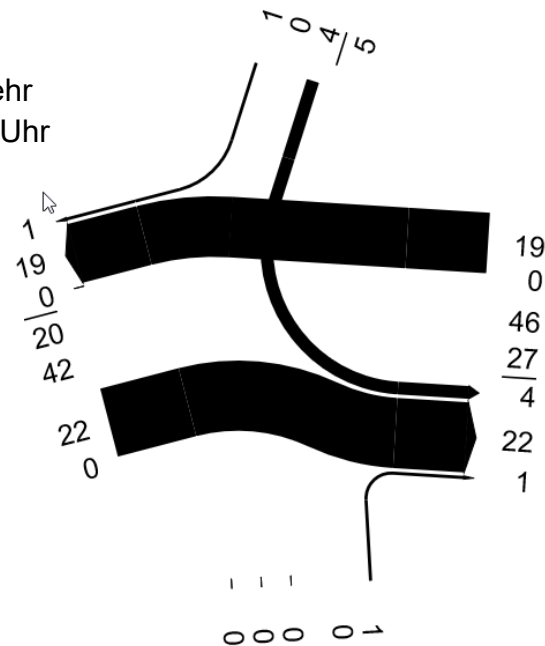

Knoten-Nr :

41403

Stadt Mainz
61.1-Stadtplanungsamt
Abtlg. Verkehrswesen

20.10.2022 dm